

# ACHTERUITRIJSSENSOREN OP LAT MET LED-AANDUIDING

Artikelnummers:

398: bedraad

94: draadloos

De achteruitrij sensoren (3 stuks) zitten in een gechromeerde metalen lat ingebouwd. De 2 buitenste staan lichtjes naar buiten gericht om zo goed de zijkant van de wagen te kunnen observeren.

## Samenstelling van een kit

1. Lat met ultrasone sensoren en microcomputer
2. LED monitor om de afstand weer te geven via gekleurde LED's en via de afstand in meter
3. Schroeven om alles te bevestigen.
4. Instructieboekje.

## Werking van het systeem

- Het systeem wordt automatisch geactiveerd wanneer de auto in achteruit wordt gezet.
- Het scherm geeft de afstand van de bumper tot het obstakel van ca 2 meter tot 30 cm
- Hoe kleiner de afstand tot het obstakel, hoe sneller de bieps volgen (bij een afstand van 30cm of kleiner is er een continue biepton te horen)

## Installatie in de wagen

- De lat met sensoren worden best onder de nummerplaat geplaatst: 50 à 80 cm boven de grond. Let erop dat er geen onderdelen binnen het detectiegebied staan ( 80 graden horizontaal en 70 graden verticaal) zoals achterop gemonteerd reservewiel.
- De lat met sensoren en microcomputer krijgt zijn stroomvoorziening via de achteruitrijlichten.
- Bij dit systeem zijn er dus geen kabels tussen de sensoren en het LED- schermpje
- Geef het led-schermpje voeding via de achteruitrijlichten of via de meegeleverde adapter voor de sigarettenaansteker.
- U krijgt de volledige uitleg voor een perfecte montage bij aankoop van uw achteruitrijstelsysteem EN ondersteuning per e-mail en/of telefoon!

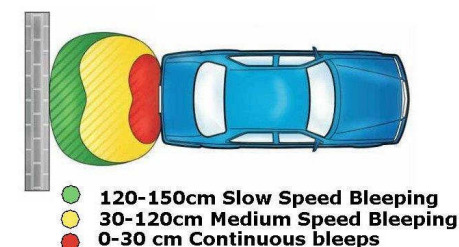

## Specificaties

- Working voltage: 12V
- Input: 4W(max)
- Beeper: 90-105dB
- Working temperature: -40 / +80°C
- Frequency: 40KHz
- Best detection distance: 0.5-1.5m
- Draadloze verbinding tussen de sensoren en het LED-schermpje

Microcomputer ingebouwd in de lat met sensoren

Het volume van de pieptonen is instelbaar: uit, zacht of hard.

Bij het draadloos systeem kan het led-scherm vast bedraad worden of via de sigarettenaansteker.

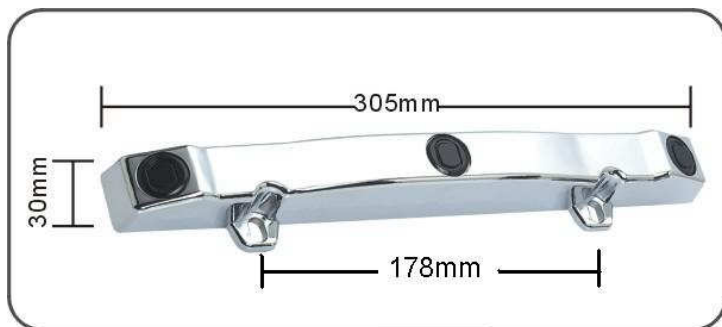

Copyright JOF electronics Belgium ©2008

<http://www.jof.be>

GSM: 0032 (0) 484 69 28 39

Last printed 29/08/2010 18:40

94\_398.doc 2/2

JOF electronics kan niet verantwoordelijk gesteld worden voor drukfouten of onjuiste informatie.

# CAR REVERSE PARKING SENSOR SYSTEM

Sophisticated anti-collision driving aid device

No drilling, install easily

Installation of  
DIY products

- Do It Yourself
- No drilling
- Voice directs safely

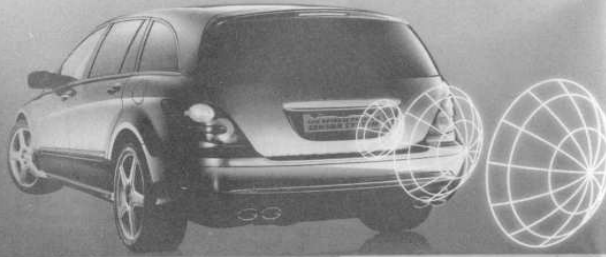

## Wireless models

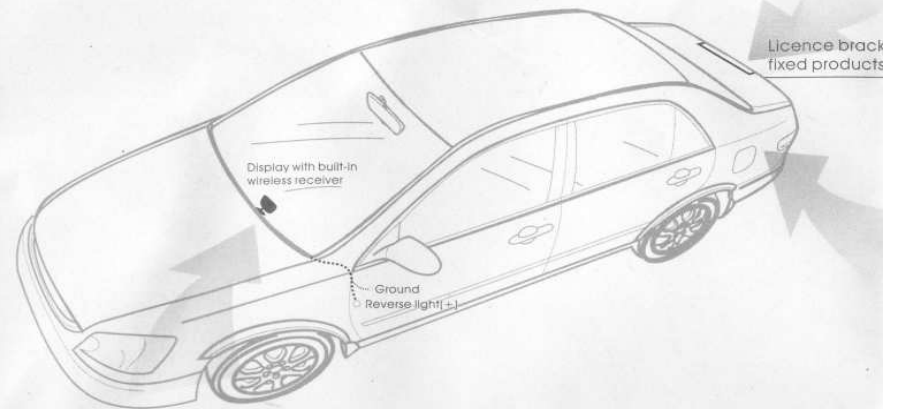

## Wire models

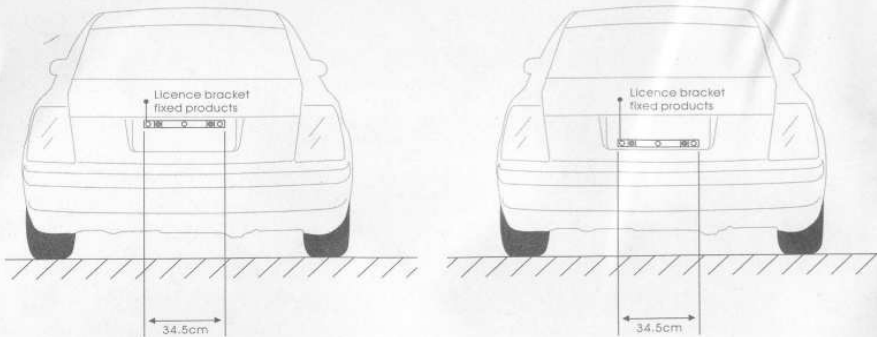
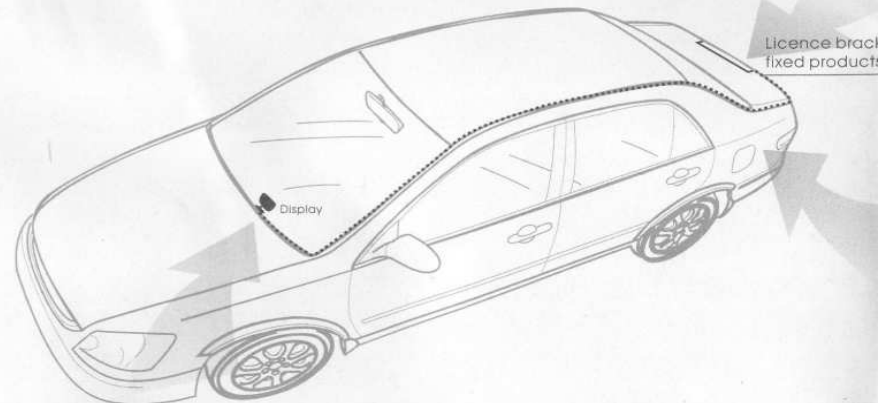

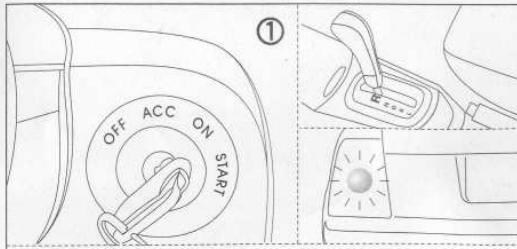

1. Tweak the key to the right side of the cigarette lighter, step on the reverse gear, the power from the reverse light will be on at once.

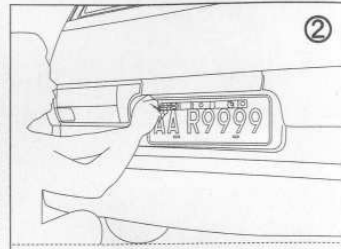

2. Remove the screws from the licence bracket, install our DIY products, reinstall the screws into the licence bracket.

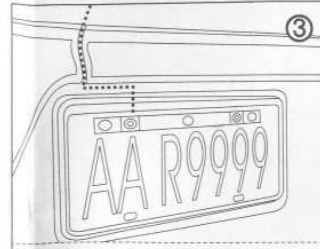

3. Tow the power line into the car through the interstices of the car.

**④ A detector to find the power**

How to find the power from the reverse light?

Introductions: Black clamp connects to the ground wire. Use the red pen to find the power from the reverse light until the LED light is on. Then connect our red power line to the power from the reverse light, and the black cathode to the ground wire.

**⑤ Installation of the display:**

- ※ According to the same method, to find the power from the reverse light in front, and connect the cables correctly as the back.
- ※ Insert the charger of the cigarette lighter to the cigarette lighter in the car to get the power.
- ※ Fix the display onto the dashboard.

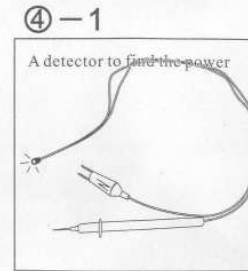
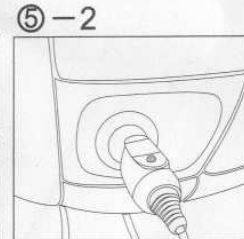
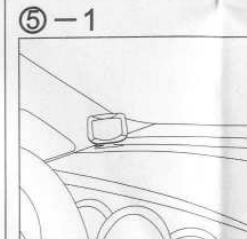

④-1

A detector to find the power

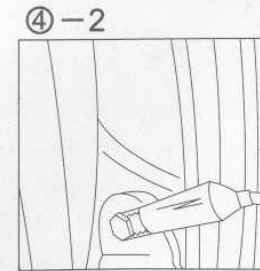

④-2

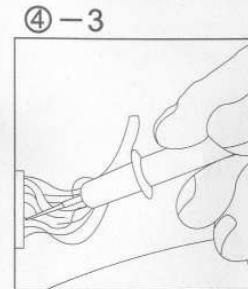

④-3

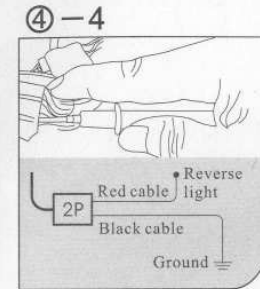

④-4

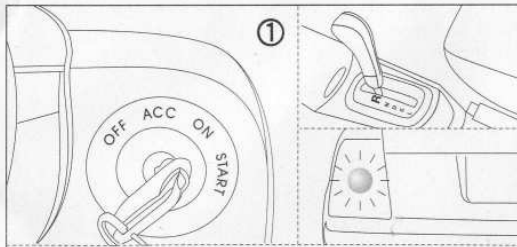
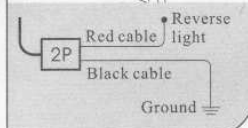

1. Tweak the key to the right side of the cigarette lighter, step on the reverse gear, the power from the reverse light will be on at once.

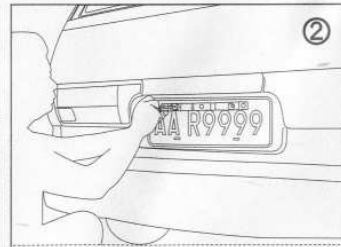

2. Remove the screws from the licence bracket, install our DIY products, reinstall the screws into the licence bracket.

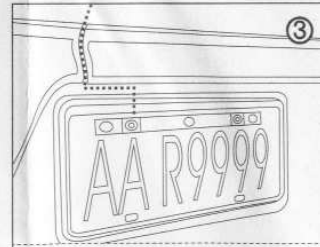

3. Tow the power line into the car through the interstices of the car.

**④ A detector to find the power**

How to find the power from the reverse light?

Introductions: Black clamp connects to the ground wire. Use the red pen to find the power from the reverse light until the LED light is on. Then connect our red power line to the power from the reverse light, and the black cathode to the ground wire.

**⑤ Installation of the display:**

- ※ Tow the cables between our DIY products and display into the front of the car through the interstices.
- ※ Fix the display onto the dashboard.

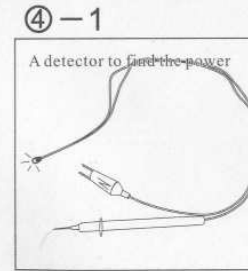
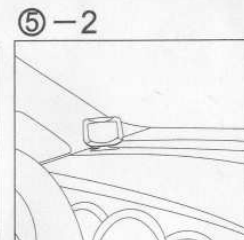
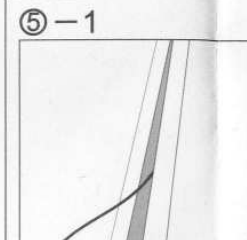

④-1

A detector to find the power

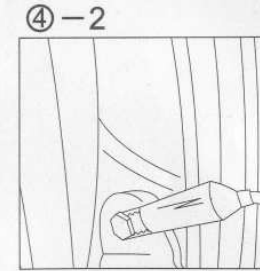

④-2

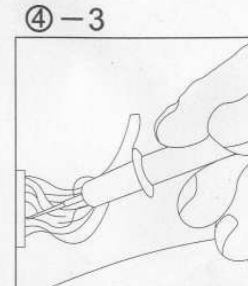

④-3

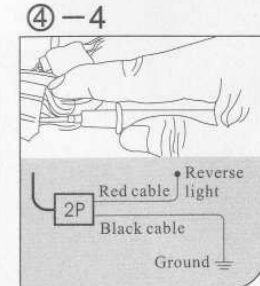

④-4

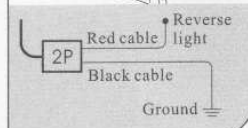

## Draadloos

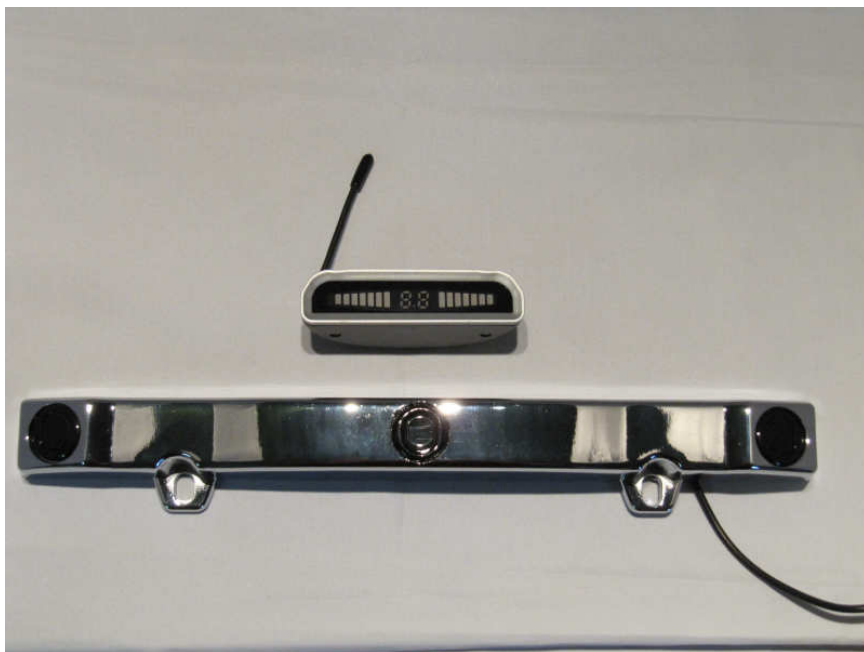

## Bedraad



Regelbaar volume: uit, zacht of hard



Kleine doorvoerstekkers die de montage vergemakkelijken

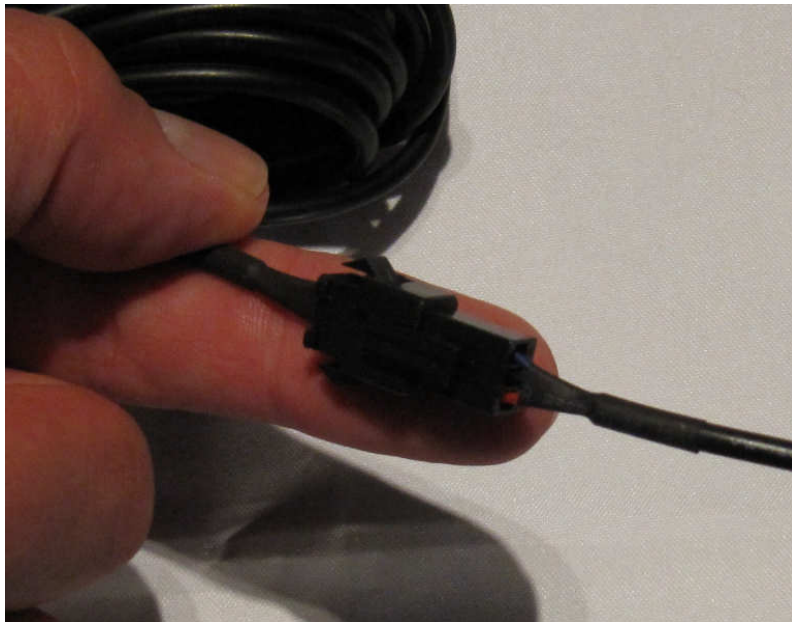

Copyright JOF electronics Belgium ©2008

<http://www.jof.be>

GSM: 0032 (0) 484 69 28 39

Last printed 29/08/2010 18:40

94\_398.doc 6/6

JOF electronics kan niet verantwoordelijk gesteld worden voor drukfouten of onjuiste informatie.